

C ONSTRUCTION

P ARTS I NC.®



ORDER
BY PHONE

TOLL FREE
1-800-222-1141

Ohio 1-800-338-5608

FAX 216-524-5682

Telephone 216-524-7100

AVAILABLE REPLACEMENT PARTS FOR STANSTEEL PLANTS

P.O. BOX 31207

CLEVELAND, OHIO 44131

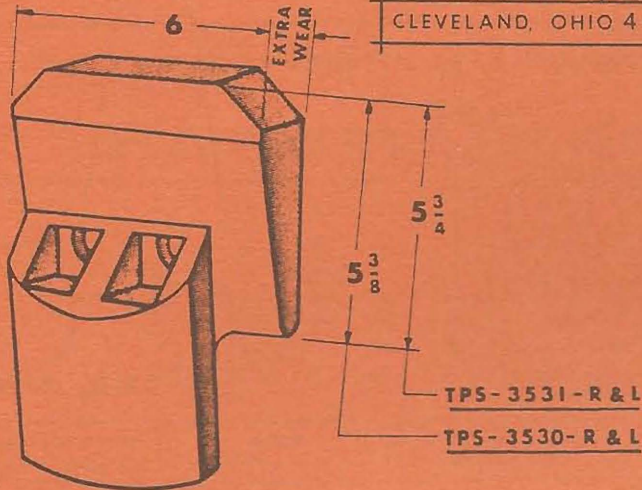

C.P.I. Part No.	O.E.M. Part No.	Description
TPS-3530-R	10523 401337 B-9248-R 401320	R.H. TIP
TPS-3530-L	10524 401336 B-9248-L 401321	L.H. TIP
TPS-3531-R	10521 401329 4631 H-B1-R 401324	R.H. TIP
TPS-3531-L	10522 401328 4631 H-B1-L 401325	L.H. TIP

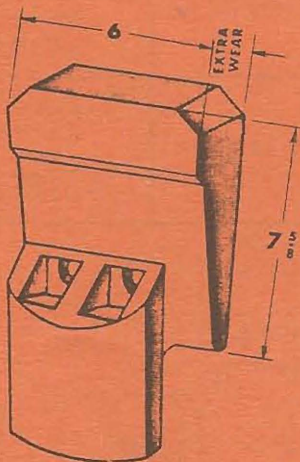

MIXER TIPS

Material: NI-HARD

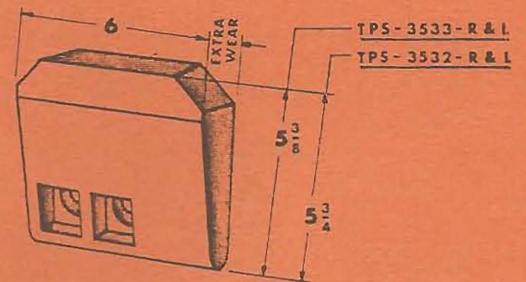

C.P.I. Part No.	O.E.M. Part No.	Description
TPS-3580-R	10532 401326 401339 C-9439-R 9629 H-B1-R	R.H. TIP
TPS-3580-L	10531 401327 401338 C-9439-L 9629 H-B1-L	L.H. TIP

C.P.I. Part No.	O.E.M. Part No.	Description
TPS-3532-R	10513 C-9500-R	R.H. TIP
TPS-3532-L	10514 C-9500-L	L.H. TIP
TPS-3533-R	10511 3456-R	R.H. TIP
TPS-3533-L	10512 3456-L	L.H. TIP



ORDER
BY PHONE

TOLL FREE
1-800-222-1141

Ohio 1-800-338-5608

FAX 216-524-5682

Telephone 216-524-7100

AVAILABLE REPLACEMENT PARTS
FOR
STANSTEEL PLANTS

MIXER SHANKS

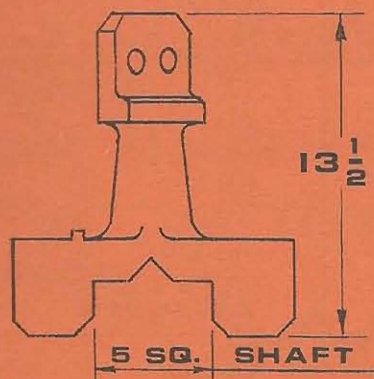

C.P.I. PART No.	REPLACEMENT FOR O.E.M. PART No.
SHK-3439-R	11024
	B3000-401-143
	PC-33-A
	401115
SHK-3439-L	11025
	B3000-401-144
	PC-33-B
	401116

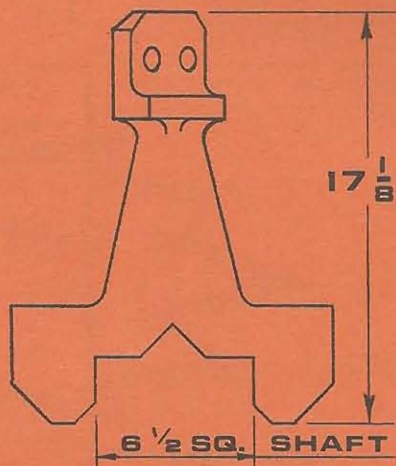

C.P.I. PART No.	REPLACEMENT FOR O.E.M. PART No.
SHK-3440-R	11030
	401127
	C-9511-R
SHK-3440-L	11031
	401128
	C-9511-L

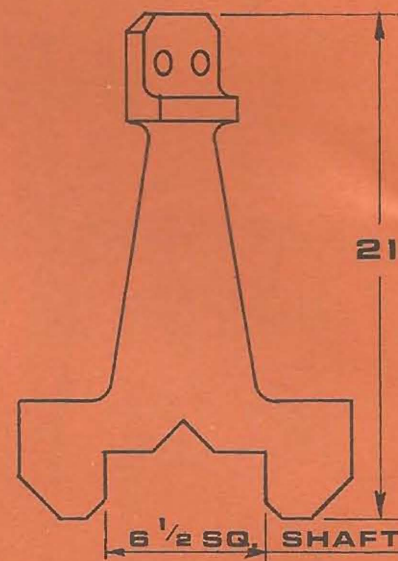

C.P.I. PART No.	REPLACEMENT FOR O.E.M. PART No.
SHK-3442-R	11048
	401131
	401133
	C-9439-R
SHK-3442-L	11047
	401132
	401134
	C-9439-L

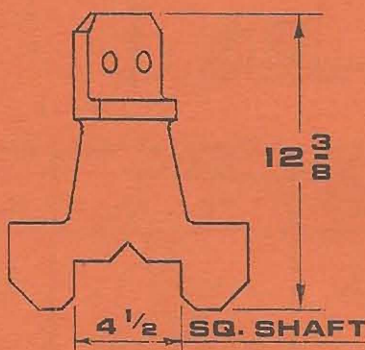

C.P.I. PART No.	REPLACEMENT FOR O.E.M. PART No.
SHK-3449-R	11022
	MD-447-AR
SHK-3449-L	11023
	MD-447-AL

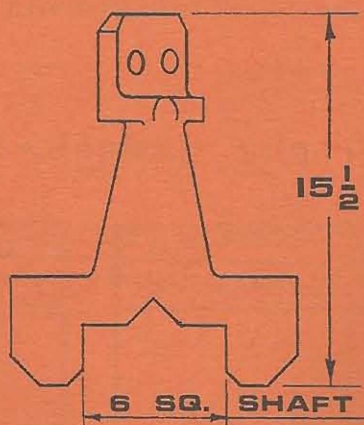

C.P.I. PART No.	REPLACEMENT FOR O.E.M. PART No.
SHK-3451-R	11026
	4090-ER
	401119
SHK-3451-L	11027
	4090-EL
	401120

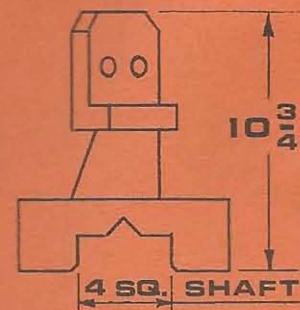

C.P.I. PART No.	REPLACEMENT FOR O.E.M. PART No.
SHK-3459-R	11020
	MD-677-ER
	11018
SHK-3459-L	11021
	MD-677-EL
	11019

"YOUR HEADQUARTERS FOR ASPHALT PLANT REPLACEMENT PARTS"

C O N S T R U C T I O N P A R T S I N C. ®



ORDER
BY PHONE

TOLL FREE
1-800-222-1141

Ohio 1-800-338-5608

FAX 216-524-5682

Telephone 216-524-7100

AVAILABLE REPLACEMENT PARTS
FOR
STANSTEEL PLANTS

MIXER COLLAR ASSEMBLY

(ALL SIZE PLANTS)

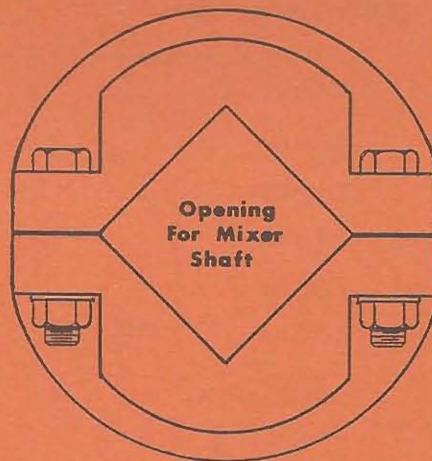

C.P.I. Part No.	Replacement for O.E.M. Part No.	Shaft Size
MXP - 7020	10012	5" Sq.
MXP - 7021	10015/401712/A9080-5	6" Sq.
MXP - 7022	10014/401714/A9510	6 1/2" Sq.
MXP - 7023	Special (16 3/4" Dia.)	6 1/2" Sq.
MXP - 7140	10010/447-C	4 1/2" Sq.
MXP - 7249	10013	4" Sq.

"YOUR HEADQUARTERS FOR ASPHALT PLANT REPLACEMENT PARTS"



ORDER
BY PHONE

TOLL FREE
1-800-222-1141

Ohio 1-800-338-5608

FAX 216-524-5682

Telephone 216-524-7100

**AVAILABLE REPLACEMENT PARTS
FOR
STANSTEEL PLANTS**

MIXER LINERS
(2,000/3,000 LB. MIXERS)

C.P.I. PART NO.	PART DESCRIPTION	REPLACEMENT FOR O.E.M. PART NO.
LNR-2530	Shell Liner	B-9497-C
LNR-2531	Shell Liner	B-9497-D
LNR-2532	Shell Liner	D-902170-A
LNR-2533	Shell Liner	D-902170-B
LNR-2534	Shell Liner	401420/ 4081-FB/ 12013
LNR-2535	Shell Liner	401921/ 4081-FC/ 12014
LNR-2536	Shell Liner	401922/ 4081-FD/ 12015
LNR-2537	End Liner	L.H. Upper
LNR-2538	End Liner	R.H. Upper
LNR-2539	End Liner	L.H. Lower Outer
LNR-2540	End Liner	R.H. Lower Outer
LNR-2541	End Liner	L.H. Lower Inner
LNR-2542	End Liner	R.H. Lower Inner

BOLTS Available For All Shell, Gate & End Liners

C O N S T R U C T I O N

P A R T S

I N C. ®



ORDER
BY PHONE

TOLL FREE
1-800-222-1141

Ohio 1-800-338-5608

FAX 216-524-5682

Telephone 216-524-7100

**AVAILABLE REPLACEMENT PARTS
FOR
STANSTEEL PLANTS**

MIXER PARTS
LINERS - COLLAR SEALS
(3,000 LBS.)

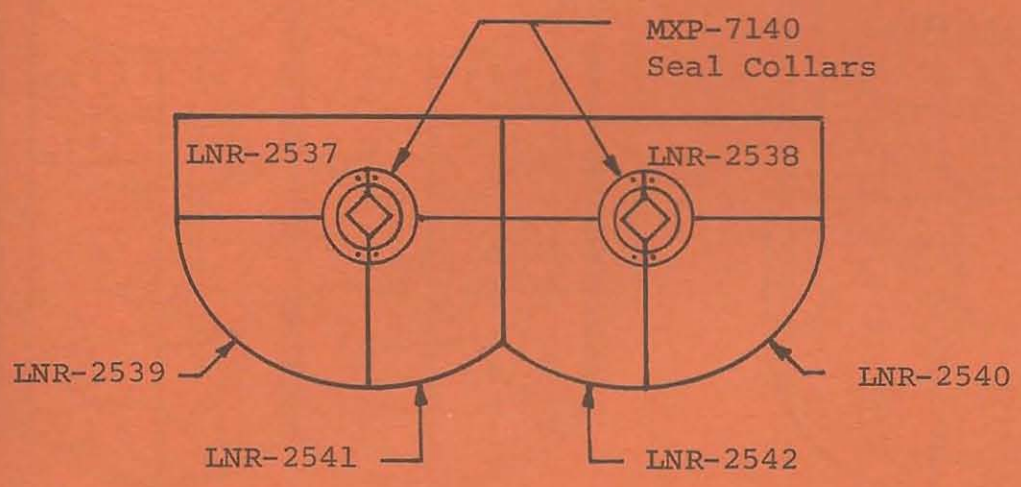

END LINERS

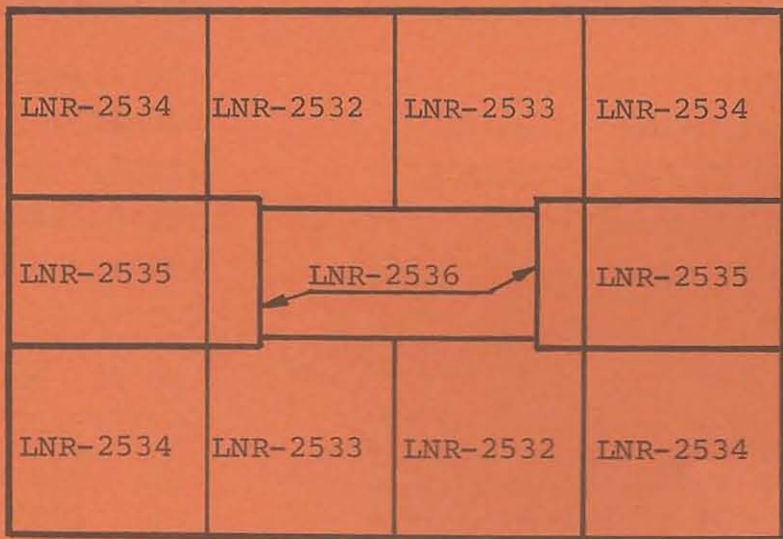

SHELL LINERS

"YOUR HEADQUARTERS FOR ASPHALT PLANT REPLACEMENT PARTS"



ORDER BY PHONE
TOLL FREE
1-800-222-1141

Ohio 1-800-338-5608

FAX 216-524-5682 Telephone 216-524-7100

**AVAILABLE REPLACEMENT PARTS
FOR
STANSTEEL PLANTS**

MIXER - 4,000 LB

MATERIAL: NI-HARD

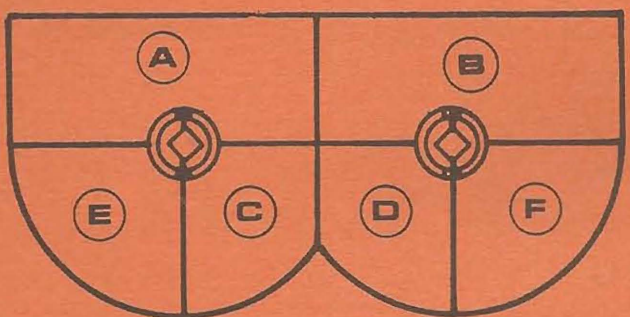

END LINERS

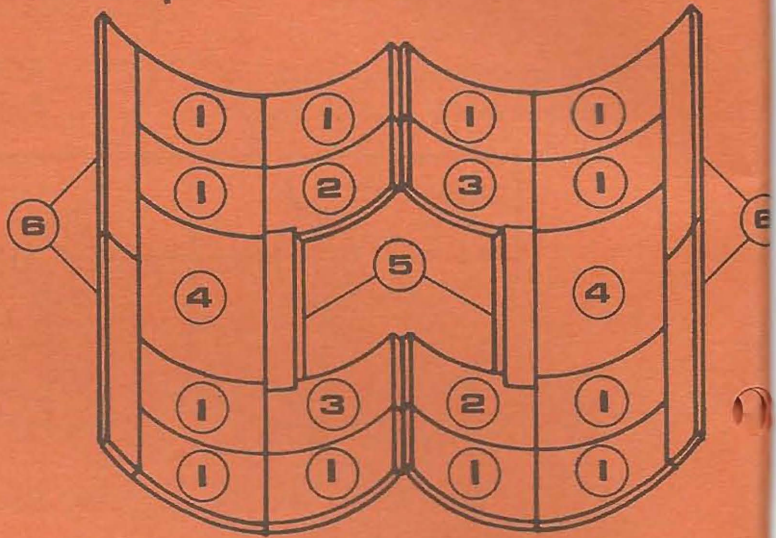

SHELL LINERS

REF.	C.P.I. PART No.	PART DESCRIPTION	REPLACEMENT FOR O.E.M. PART No.
1	LNR-2346	Shell Liner	12017/ 4089-F1-C2-2
2	LNR-2349	Shell Liner (Lipped)	12034/ 90219-A
3	LNR-2348	Shell Liner (Lipped)	12035/ 90219-B
4	LNR-2347	Shell Liner	12016/ 4089-F1-C2-1
5	LNR-2350	Shell Liner	12018/ 4089-F1-C2-3
6	LNR-2351	Top Side Liner	C-9096-C/ C-9096-3SC
			12 Pc. Set #C9097-6
			Consists Of:
A	LNR-2387	Top End Liner	01021
B	LNR-2388	Top End Liner	01018
C	LNR-2389	Bottom Center End Liner	01020
D	LNR-2390	Bottom Center End Liner	01017
E	LNR-2391	Bottom Corner End Liner	01019
F	LNR-2392	Bottom Corner End Liner	01016

BOLTS Available For All Shell, Gate & End Liners

"YOUR HEADQUARTERS FOR ASPHALT PLANT REPLACEMENT PARTS"

C O N S T R U C T I O N P A R T S I N C. ®



ORDER
BY PHONE

TOLL FREE
1-800-222-1141

Ohio 1-800-338-5608

FAX 216-524-5682

Telephone 216-524-7100

AVAILABLE REPLACEMENT PARTS
FOR
STANSTEEL PLANTS

MIXER - 5,000 LB.

MATERIAL: NI-HARD

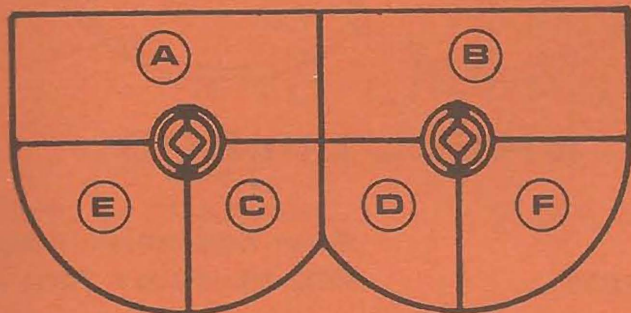

END LINERS

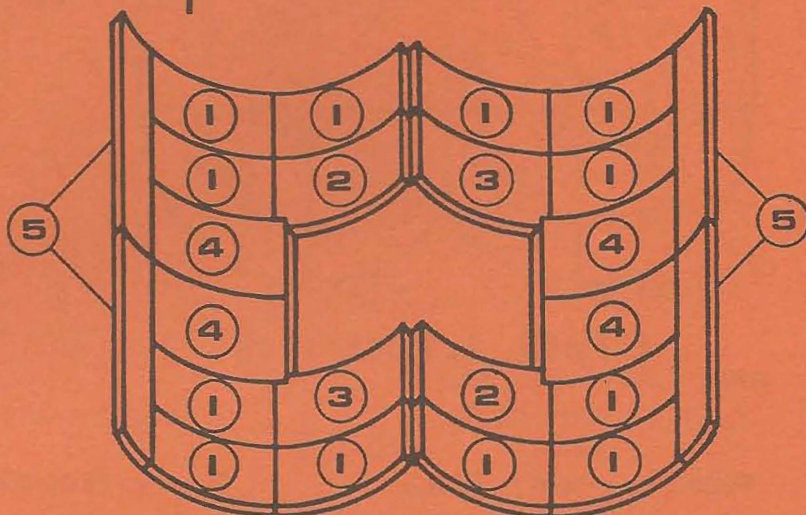

SHELL LINERS

REF.	C.P.I. PART NO.	PART DESCRIPTION	REPLACEMENT FOR O.E.M. PART NO.
1	LNR-2352	Shell Liner	12019/ 4133-H-C1-1/ 401928 47-700-098-01-001
2	LNR-2355	Shell Liner (Lipped)	12036/ 4133-H-C1-3/ 401965
3	LNR-2354	Shell Liner (Lipped)	12037/ 4133-H-C1-4/ 401966
4	LNR-2353	Shell Liner	12020/ 4133-H-C1-2/ 401929 47-700-099-01-001
5	LNR-2356	Top Side Shell Liner	01029
A	LNR-2394	Top End Liner	01028
B	LNR-2398	Top End Liner	01025
C	LNR-2396	Bottom Center End Liner	01027
D	LNR-2395	Bottom Center End Liner	01024
E	LNR-2393	Bottom Corner End Liner	01026
F	LNR-2397	Bottom Corner End Liner	01023

BOLTS Available For All Shell, Gate & End Liners

"YOUR HEADQUARTERS FOR ASPHALT PLANT REPLACEMENT PARTS"

MIXER
6,000 LB.

MATERIAL: NI-HARD

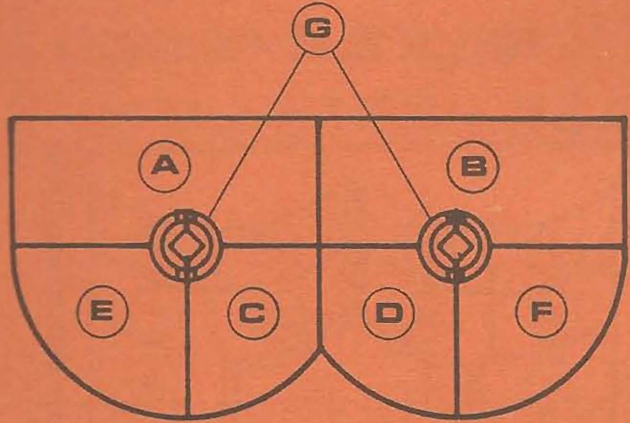

END LINERS

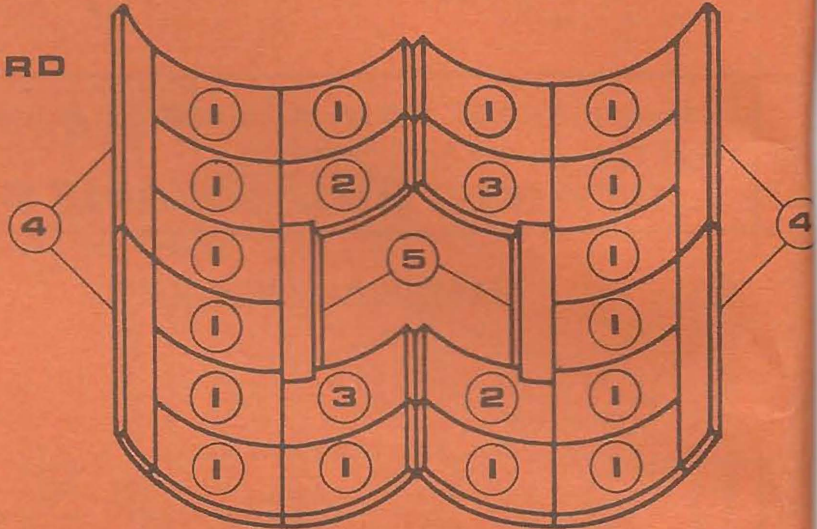

SHELL LINERS

REF.	C.P.I. PART NO.	PART DESCRIPTION	REPLACEMENT FOR O.E.M. PART NO.
1	LNR-2358	Shell Liner	12021/ 4090-A/ 401938
2	LNR-2360	Shell Liner (Lipped)	12038/ 90223-A/ 401936
3	LNR-2361	Shell Liner (Lipped)	12039/ 90223-B/ 401937
4	LNR-2357	Top Side Liner	01036
5	LNR-2359	Shell Liner	12022/ 4090-B/ 401939
	LNR-2377-1	Gate Liner	12074/ 401940 47-000-169-00-001
	LNR-2377-2	Gate Liner	12075/ 401941 47-000-173-00-001
			12 Pc. Set #C-9505-4 Consists Of:
A	LNR-2399	Top End Liner	01035
B	LNR-2400	Top End Liner	01032
C	LNR-2401	Bottom Center End Liner	01033
D	LNR-2402	Bottom Center End Liner	01030
E	LNR-2403	Bottom Corner End Liner	01034
F	LNR-2404	Bottom Corner End Liner	01031

BOLTS Available For All Shell, Gate & End Liners

**MIXER
7,000 LB.**

MATERIAL: NI-HARD

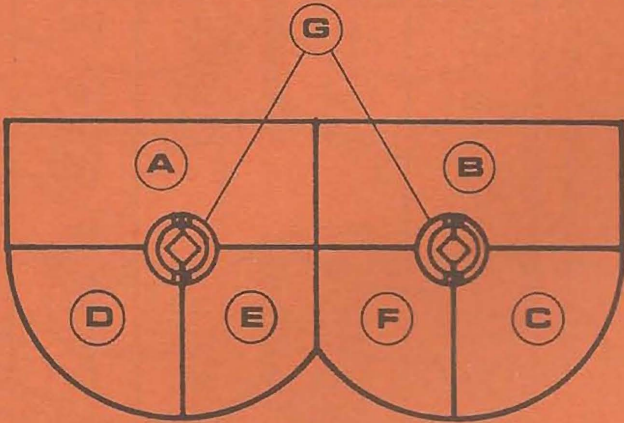

END LINERS

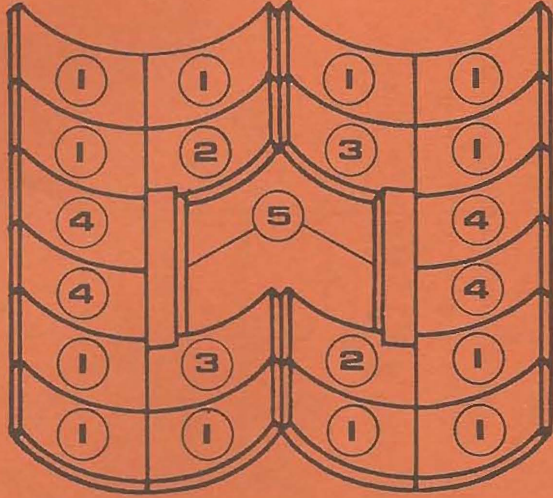

SHELL LINERS

REF.	C.P.I. PART NO.	PART DESCRIPTION	REPLACEMENT FOR O.E.M. PART No.
1	LNR-2362	Shell Liner	12025/ 401944
2	LNR-2364	Shell Liner (Lipped)	12048/ 401942
3	LNR-2365	Shell Liner (Lipped)	12049/ 401943
4	LNR-2363	Shell Liner	12026/ 401945
5	LNR-2366	Shell Liner	12027/ 401946
	LNR-2718	Top Shell Liner	C-95132-SB
	LNR-2721	Gate Liner	12071/ 401947
	LNR-2722	Gate Liner	12072/ 401948
			12 Pc. Set #C-9513-2 Consists Of:
A	LNR-2439	Top End Liner	01042
B	LNR-2440	Top End Liner	01039
C	LNR-2441	Bottom Corner End Liner	01038
D	LNR-2442	Bottom Corner End Liner	01041
E	LNR-2633	Bottom Center End Liner	01040
F	LNR-2634	Bottom Center End Liner	01037

BOLTS Available For All Shell, Gate & End Liners



ORDER
BY PHONE

TOLL FREE
1-800-222-1141

Ohio 1-800-338-5608

FAX 216-524-5682

Telephone 216-524-7100

AVAILABLE REPLACEMENT PARTS
FOR
STANSTEEL PLANTS

MIXER
8,000 LB.

MATERIAL: NI-HARD

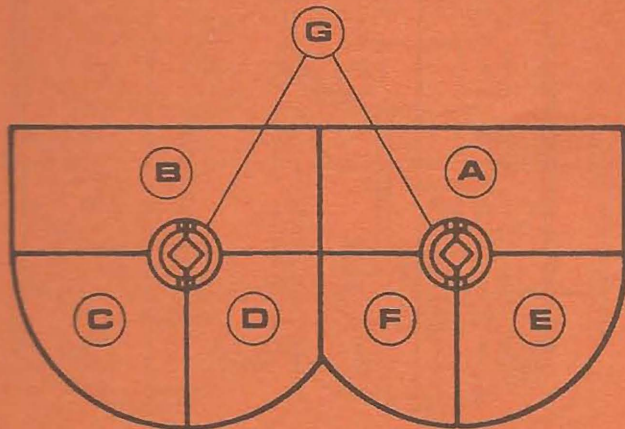

END LINERS

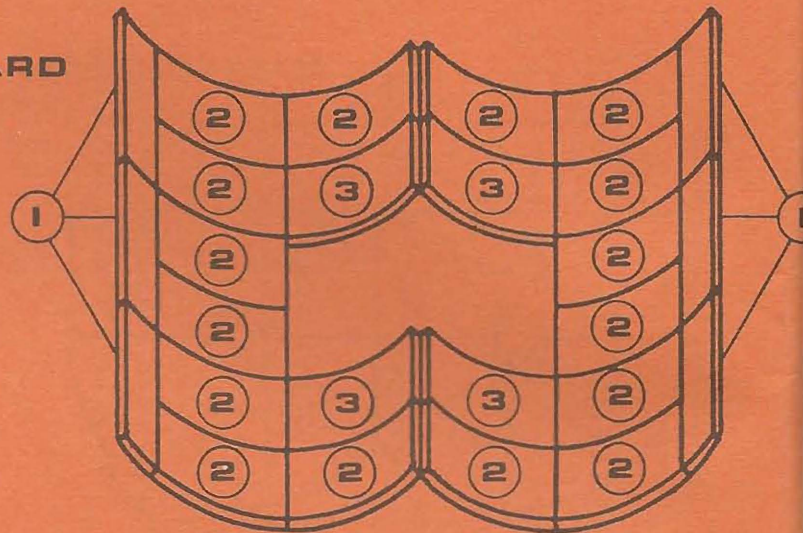

SHELL LINERS

REF.	C.P.I. PART No.	PART DESCRIPTION	REPLACEMENT FOR O.E.M. PART No.
1	LNR-2370	Shell Liner	12044/ D-90361-C/ 401951
2	LNR-2368	Shell Liner	12042/ D-90361-A/ 401949
3	LNR-2369	Shell Liner	12043/ D-90361-B/ 401950
	LNR-2714-A	Gate Liner	12064/ 401952/ E-90092-A 47-000-171-001
	LNR-2714-B	Gate Liner	12065/ 401953/ E-90092-B 47-000-176-001
			12 Pc. Set #C-9575 Consists Of:
A	LNR-2443	Top End Liner	01046/ 500250
B	LNR-2444	Top End Liner	01049/ 500251
C	LNR-2445	Bottom Corner End Liner	01048/ 500255
D	LNR-2446	Bottom Center End Liner	01047/ 500253
E	LNR-2447	Bottom Corner End Liner	01045/ 500254
F	LNR-2635	Bottom Center End Liner	01044/ 500252

BOLTS Available For All Shell, Gate & End Liners

"YOUR HEADQUARTERS FOR ASPHALT PLANT REPLACEMENT PARTS"



ORDER
BY PHONE

TOLL FREE
1-800-222-1141

Ohio 1-800-338-5608

FAX 216-524-5682

Telephone 216-524-7100

AVAILABLE REPLACEMENT PARTS
FOR
STANSTEEL PLANTS

MIXER
10,000 LB.

MATERIAL: NI-HARD

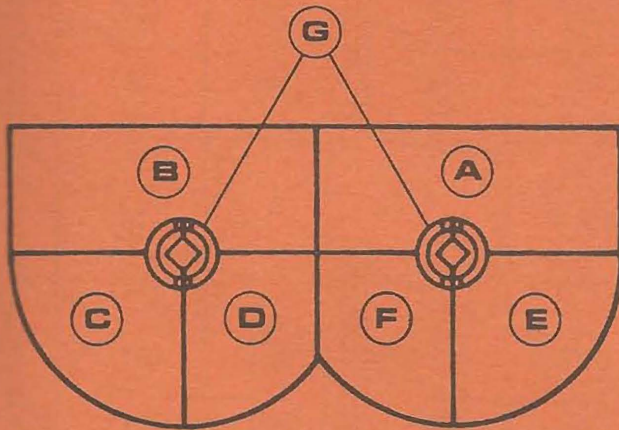

END LINERS

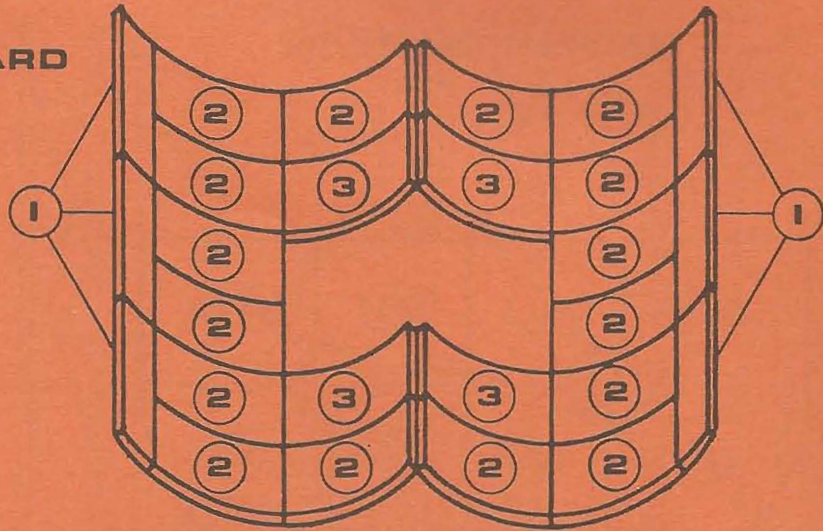

SHELL LINERS

REF.	C.P.I. PART NO.	PART DESCRIPTION	REPLACEMENT FOR O.E.M. PART NO.
1	LNR-2370	Shell Liner	12044/ D-90361-C/ 401951
2	LNR-2368	Shell Liner	12042/ D-90361-A/ 401949
3	LNR-2369	Shell Liner	12043/ D-90361-B/ 401950
	LNR-2714-A	Gate Liner	12064/ 401952/ E-90092-A 47-000-171-001
	LNR-2714-B	Gate Liner	12065/ 401953/ E-90092-B 47-000-176-001
			12 Pc. Set #C-9575 Consists Of:
A	LNR-2443	Top End Liner	01046/ 500250
B	LNR-2444	Top End Liner	01049/ 500251
C	LNR-2445	Bottom Corner End Liner	01048/ 500255
D	LNR-2446	Bottom Center End Liner	01047/ 500253
E	LNR-2447	Bottom Corner End Liner	01045/ 500254
F	LNR-2635	Bottom Center End Liner	01044/ 500252

BOLTS Available For All Shell, Gate & End Liners

"YOUR HEADQUARTERS FOR ASPHALT PLANT REPLACEMENT PARTS"

MIXER
12,000 Lb.

MATERIAL: NI-HARD

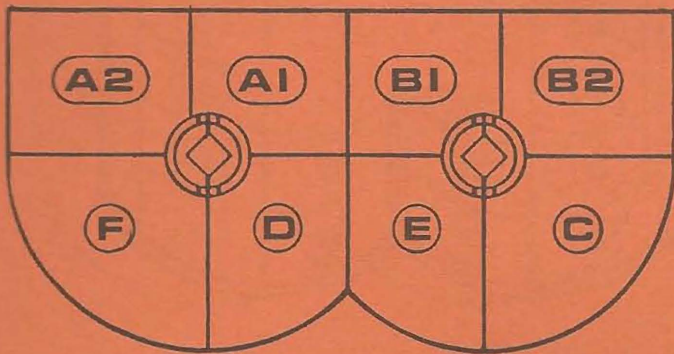

END LINERS

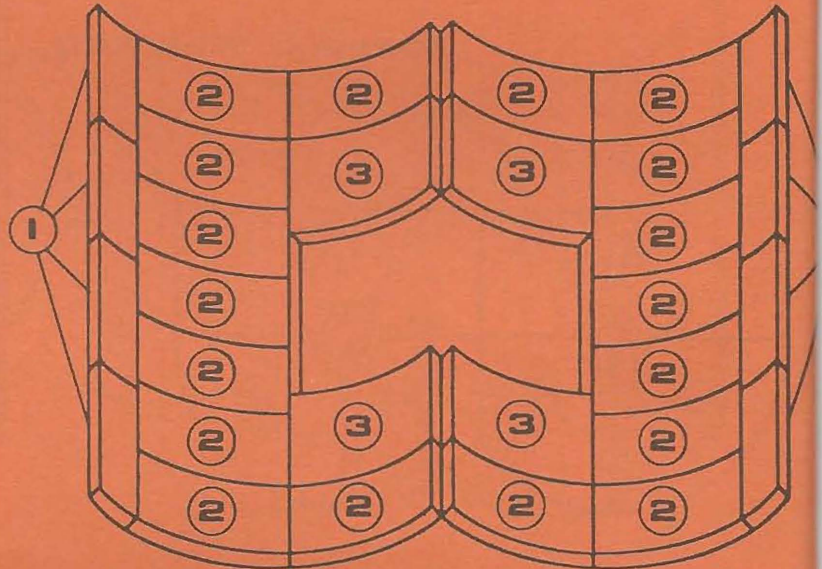

SHELL LINERS

REF.	C.P.I. PART No.	PART DESCRIPTION	REPLACEMENT FOR O.E.M. PART No.
1	LNR-2371	Shell Liner	12066/ 91540-A/ 401954 47-700-553-001
2	LNR-2372	Shell Liner	12067/ 91540-B/ 401955 47-700-554-001
3	LNR-2373	Shell Liner	12068/ 91540-C/ 401956 47-800-375-01
A1	LNR-2448-1	Top End Liner - Split Type	01051/ 500258
A2	LNR-2448-2	Top End Liner - Split Type	01051/ 500258
B1	LNR-2449-1	Top End Liner - Split Type	01052/ 500257
B2	LNR-2449-2	Top End Liner - Split Type	01052/ 500257
C	LNR-2450	Bottom Corner End Liner	01056/ 500261
D	LNR-2451	Bottom Center End Liner	01055/ 500260
E	LNR-2452	Bottom Center End Liner	01054/ 500259
F	LNR-2636	Bottom Corner End Liner	01053/ 500262

BOLTS Available For All Shell, Gate & End Liners

"YOUR HEADQUARTERS FOR ASPHALT PLANT REPLACEMENT PARTS"

MIXER
16,000 LB.

MATERIAL: NI-HARD

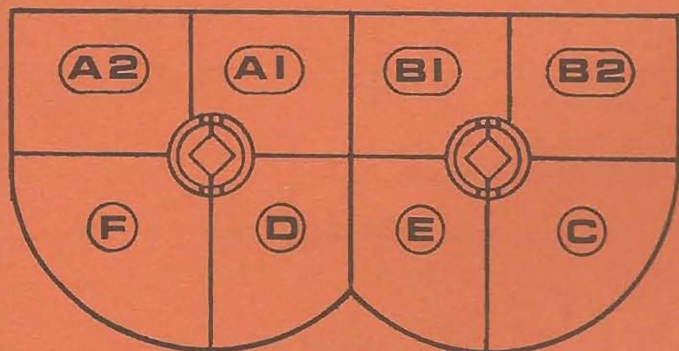

END LINERS

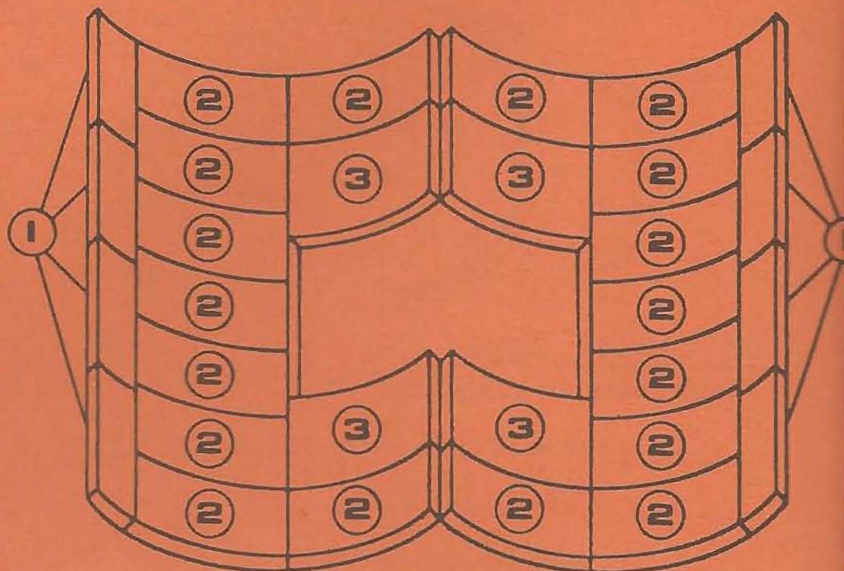

SHELL LINERS

REF.	C.P.I. PART No.	PART DESCRIPTION	REPLACEMENT FOR O.E.M. PART No.
1	LNR-2371	Shell Liner	12066/ 91540-A/ 401954 47-700-553-001
2	LNR-2372	Shell Liner	12067/ 91540-B/ 401955 47-700-554-001
3	LNR-2373	Shell Liner	12068/ 91540-C/ 401956 47-800-375-01
A1	LNR-2448-1	Top End Liner - Split Type	01051/ 500258
A2	LNR-2448-2	Top End Liner - Split Type	01051/ 500258
B1	LNR-2449-1	Top End Liner - Split Type	01052/ 500257
B2	LNR-2449-2	Top End Liner - Split Type	01052/ 500257
C	LNR-2450	Bottom Corner End Liner	01056/ 500261
D	LNR-2451	Bottom Center End Liner	01055/ 500260
E	LNR-2452	Bottom Center End Liner	01054/ 500259
F	LNR-2636	Bottom Corner End Liner	01053/ 500262

BOLTS Available For All Shell, Gate & End Liners

"YOUR HEADQUARTERS FOR ASPHALT PLANT REPLACEMENT PARTS"

DRYER PARTS

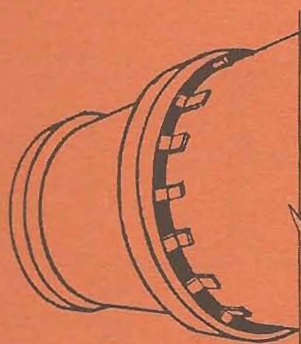

DRYER TIRES

C.P.I. PART No.	PART DESCRIPTION	REPLACEMENT FOR O.E.M. PART No.
DRP-4663	Dryer Tire	03005
DRP-4664	Dryer Tire	03006 530613
DRP-4665	Dryer Tire	03009

To Obtain Quote.....
(Need following information)

AVAILABLE

_____ O.D. Dryer Tire 72" Thru 126" Dia. Dryer Shell Tires
_____ I.D. Dryer Tire
_____ Width (Dryer Tire)

RING GEARS

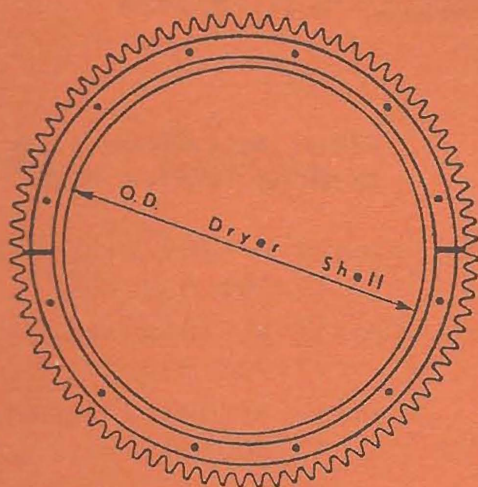

C.P.I. PART No.	PART DESCRIPTION	REPLACEMENT FOR O.E.M. PART No.
TRP-443	124 Tooth Ring Gear	B-C2-CA
TRP-372	132 Tooth Ring Gear	04127 D-90272
TRP-444	142 Tooth Ring Gear	04028
TRP-445	144 Tooth Ring Gear	04129 532611
TRP-446	148 Tooth Ring Gear	04152 D-91349-15A
TRP-198	178 Tooth Ring Gear	04175



DRYER DRIVE PINIONS

C.P.I. PART No.	PART DESCRIPTION	REPLACEMENT FOR O.E.M. PART No.
TRP-395	12 Tooth Pinion	11013/ 11050 533503 47-800-443-501
TRP-396	14 Tooth Pinion	11015
TRP-397	19 Tooth Pinion	D-91220-1A
TRP-398	21 Tooth Pinion	04165



ORDER
BY PHONE

TOLL FREE
1-800-222-1141

Ohio 1-800-338-5608

FAX 216-524-5682

Telephone 216-524-7100

Replacement Dryer Trunnions

Dimensions needed from you to obtain Quote....

- A _____ Trunnion Diameter
- B _____ Trunnion Face (Width)
- C _____ Shaft Projection
- D _____ Shaft Projection
- E _____ Trunnion Face
- _____ Shaft Diameter without keyway
- _____ Shaft Diameter with keyway on C _____ or D _____ Size _____ x _____

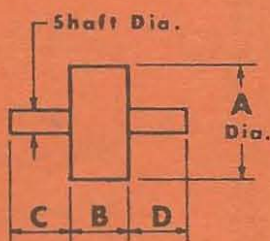

Plain Trunnion

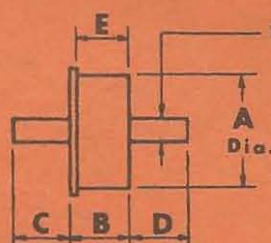

Single Flange Trunnion

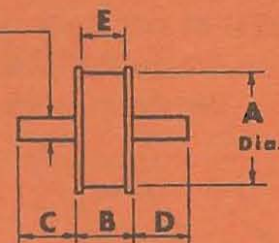

Double Flange Trunnion

C.P.I.
PART NO.

PART DESCRIPTION

REPLACEMENT FOR
O.E.M. PART NO.

DRP-4667	Double Flange Trunnion	10048
DRP-4668	Single Flange Trunnion	10052
		B900005AC
DRP-4519	Single Flange Trunnion	10090
DRP-4523	Single Flange Trunnion	10091
DRP-4669	Single Flange Trunnion	10094
DRP-4670	Single Flange Trunnion	11055
DRP-4671	Single Flange Trunnion	531611
DRP-4437	Single Flange Trunnion	11052
DRP-4497	Single Flange Trunnion	531038

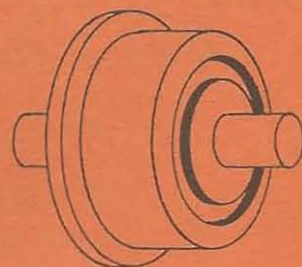

DRYER FLIGHTS
(With Bolt-On Clips)

SERRATED FLIGHTS
Type "A" & "AA"
(With Bolt-On Clips)

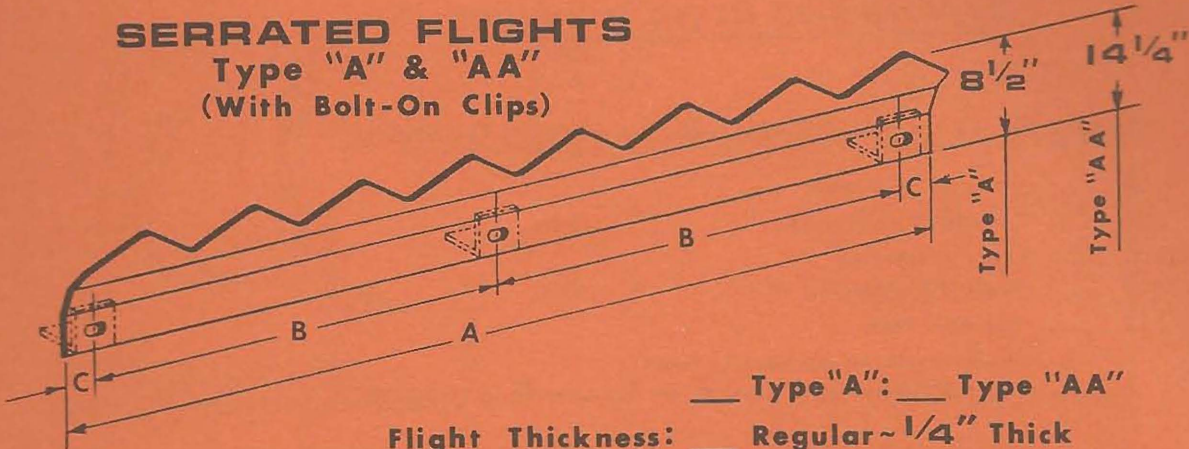

Flight Thickness: Type "A": Type "AA"
 Regular ~ 1/4" Thick
 Extra Thick ~ 3/8" Thick

Information Needed to Quote Serrated Flights

Type _____
Thickness _____
A _____
B _____
C _____
No. of Bolt-On Clips _____

SERRATED FLIGHTS
Type "B" & "BB"
(With Bolt-On Clips)

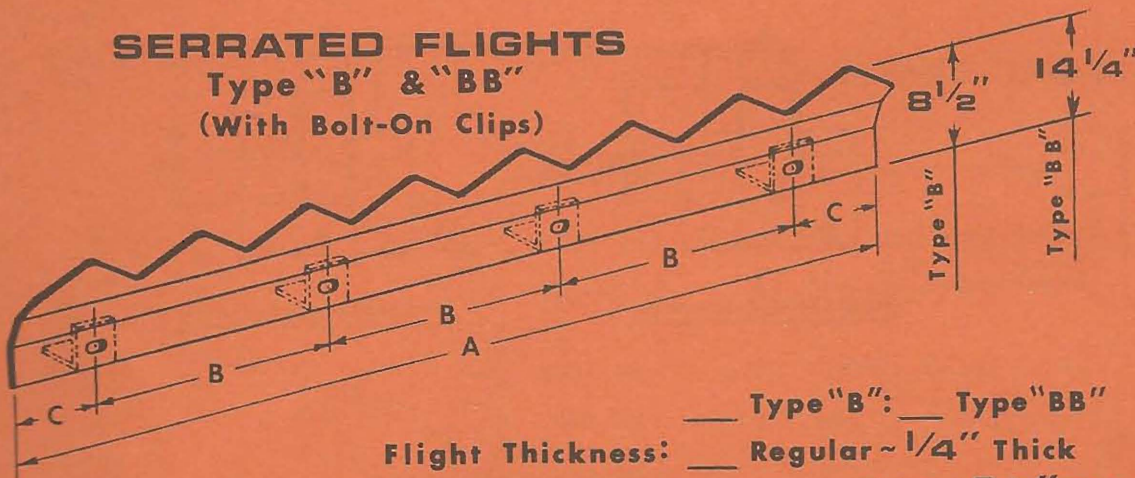

Flight Thickness: Type "B": Type "BB"
 Regular ~ 1/4" Thick
 Extra Thick ~ 3/8" Thick

Information Needed to Quote Channel Flights

A _____
B _____
C _____
D _____
E _____
F _____

CHANNEL FLIGHTS

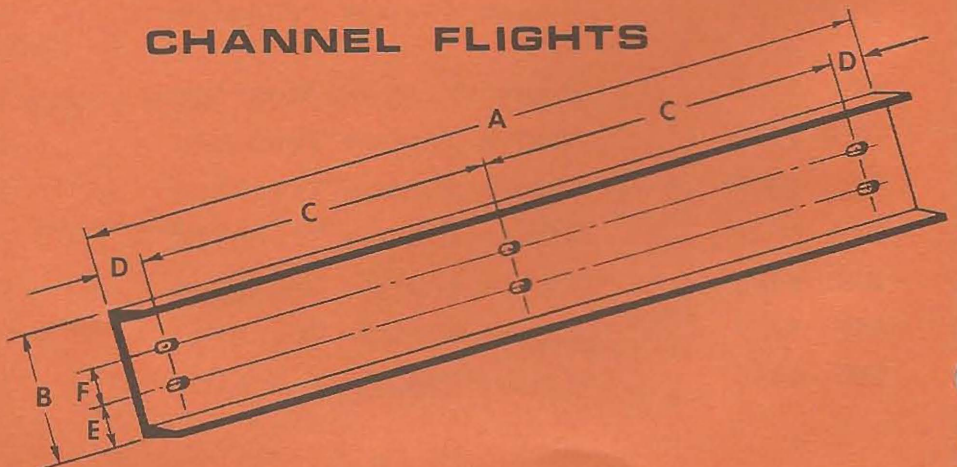

ELEVATOR
Traction Wheels

C.P.I. PART NO.	PART DESCRIPTION	REPLACEMENT FOR O.E.M. PART NO.
ETW-5402	Traction Wheel	10089-A 500724
ETW-5403	Traction Wheel	10088
ETW-5404	Traction Wheel	L-D1-CG 10036
ETW-5406	Traction Wheel	B-9157-4 500711
ETW-5408	Traction Wheel	10085 500707
ETW-5411	Traction Wheel	L-D1-CD 10039
ETW-5415	Traction Wheel	10084
ETW-5445	Traction Wheel	10083
ETW-5446	Traction Wheel	B-9319-4
ETW-5447	Traction Wheel	B-9318-3 10087
ETW-5448	Traction Wheel	10041

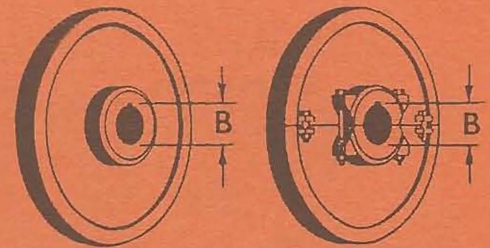

TRACTION WHEELS
Solid Type Split Type

TRACTION WHEELS
COMPLETE W/ HUB
(Including Standard Keyway
And Set Screws)

Information Required
To Quote

Solid Type Split Type
Wheel Diameter _____
Chain Size _____
Bore Diameter "B" _____
(Shaft Diameter)

SPROCKET PART NO.	TRACTION WHEEL PART NO.	HUB BODY NO.	BOLT CIRCLE DIAMETER	BOLT SIZE	A	C	D	E
TRP-1010	ETW-1010	CPI-1010	10	1/2	8-1/2	5/8	12-1/4	11-3/4
TRP-1212	ETW-1212	CPI-1212	12	5/8	10-1/2	3/4	14-1/4	13-3/4
TRP-1616	ETW-1616	CPI-1616	16	3/4	14-1/2	3/4	18-1/4	17-3/4
TRP-2020	ETW-2020	CPI-2020	20	3/4	18-1/2	7/8	22-1/4	21-3/4
TRP-2525	ETW-2525	CPI-2525	25	1	23	1	28-1/4	27-3/4

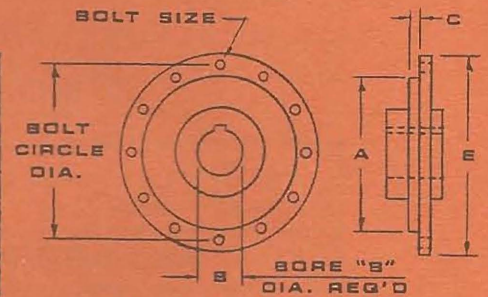

BODY HUB

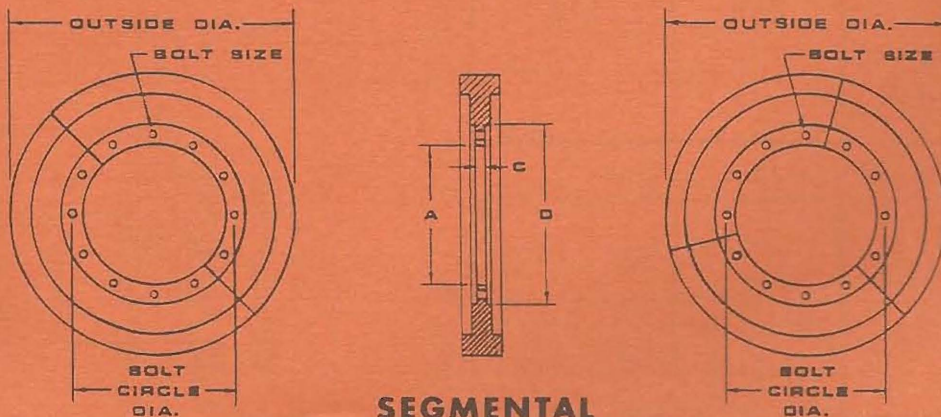

SEGMENTAL TRACTION WHEELS (2) SEGMENTS (3) SEGMENTS

TRACTION WHEELS
To Order, Specify

Outside Dia. _____
Chain Size _____
(2) Segments
or
(3) Segments _____
Bore Diameter "B" _____
(Shaft Diameter)

CONSTRUCTION

**PARTS
INC.®**



ORDER
BY PHONE

TOLL FREE
1-800-222-1141

Ohio 1-800-338-5608

FAX 216-524-5682

Telephone 216-524-7100

AVAILABLE REPLACEMENT PARTS
FOR
STANSTEEL PLANTS

**SPROCKETS
ROLLER CHAINS**

C.P.I.

PART No.

PART DESCRIPTION

TRP-212	17 Tooth Sprocket
TRP-220	15 Tooth Sprocket
TRP-221	70 Tooth Sprocket
TRP-457	40 Tooth Sprocket
TRP-458	54 Tooth Sprocket
TRP-459	43 Tooth Sprocket
TRP-460	50 Tooth Sprocket
TRP-461	50 Tooth Sprocket
TRP-462	40 Tooth Sprocket
TRP-463	16 Tooth Sprocket
TRP-464	70 Tooth Sprocket
TRP-465	18 Tooth Sprocket
TRP-466	37 Tooth Sprocket

**REPLACEMENT FOR
O.E.M. PART No.**

D-9618-3R
C9051-OCA/ L-C1-CA
D-9618-3Q
04044
04047
40536H/C1-0
C90043-4/ 04048
B9342-2SA
04168
C901430
40167L/D2-2R
40167L/D2-OA
A-9488-OA
A-9488-OB

ROLLER CHAIN

C.P.I. PART No.	PITCH	ROLLER	
		DIA. A	WIDTH B
ROLLER CHAIN - Single Strand			
DCH-60	3/4	15/32	1/2
DCH-80	1	5/8	5/8
DCH-100	1 1/4	3/4	3/4
DCH-120	1 1/2	7/8	1
ROLLER CHAIN - Double Strand			
DCH-120-2	1 1/2	7/8	1
DCH-140-2	1 3/4	1	1
DCH-200-2	2 1/2	1 9/16	1 1/2
DCH-240-2	3	1 7/8	1 7/8

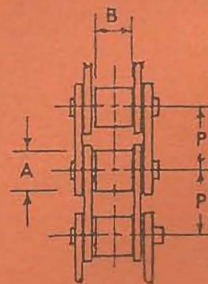

Single Strand

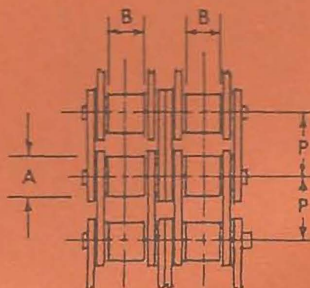

Double Strand

"YOUR HEADQUARTERS FOR ASPHALT PLANT REPLACEMENT PARTS"

SPROCKETS
ROLLER CHAIN

DRIVE CHAIN SPROCKETS

(Including Standard Keyway
And Set Screws)

Information Required To Quote

Number Of Teeth _____
Chain Size _____
Single Strand Chain _____
Double Strand Chain _____
Bore Diameter (Shaft Diameter)
Type "B" _____ Type "C" _____

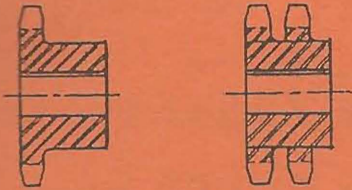

Type "B"
Hub - One Side

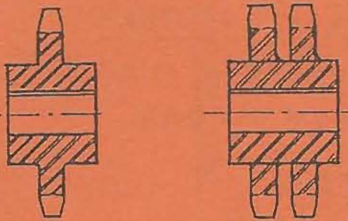

Type "C"
Hub - Both Sides

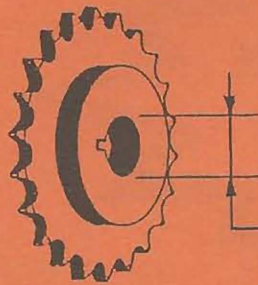

C.P.I.
PART NO.

PART DESCRIPTION

REPLACEMENT FOR
O.E.M. PART NO.

TRP-201	17 Tooth Sprocket	40405L/D1-OK
TRP-203	70 Tooth Sprocket	C9051-OCB/ L-C1-CB
TRP-447	17 Tooth Sprocket	E95731G/ E9573-7G
TRP-448	26 Tooth Sprocket	E95731F/ 040010 E90027-1F
TRP-449	14 Tooth Sprocket	D90095-OB
TRP-450	22 Tooth Sprocket	D90095-OC
TRP-451	11 Tooth Sprocket	E9872-4H
TRP-452	35 Tooth Sprocket	E9872-4J
TRP-453	18 Tooth Sprocket	A9488-OA
TRP-454	37 Tooth Sprocket	A9488-OB
TRP-455	19 Tooth Sprocket	E9889-2B
TRP-456	28 Tooth Sprocket	E9889-2C